



ALL-IN-ONE SOLAR STREET LIGHT

# iSSL Maxi Area

MADE IN FRANCE



l'intelligence  
solaire solar  
intelligence

# iSSL Maxi Area



WARRANTY  
6 YEARS

MADE IN FRANCE



FUNCTION  
ANTI BLACKOUT



COMMUNICATION &  
REMOTE SUPERVISION



PLUG & PLAY



UNIQUE RESISTANCE  
TO EXTREME CLIMATES

iSSL Maxi Area is an all-in-one, reliable and robust solar lighting solution that's quick and easy to install (set-up takes less than 10 minutes). This innovative device is particularly well-suited to lighting pedestrian walkways and cycle paths, for which it offers unrivalled performance and connected services.

The product is controlled by a smartphone monitoring application, SunnAPP, with a motion detection option.



1

## HORIZONTAL SOLAR PANELS

*Dedicated to tropical and temperate zones  
Self-cleaning coating  
No dust accumulation*

2

## HIGH-PERFORMANCE NiMH BATTERY

*Resistant to extreme conditions  
Long lifespan (average of 12 years)*

3

## SUNNACORE

*Electronic board with Bluetooth connection  
Intelligent energy management system to maximise  
battery life and optimise lighting all year round*

4

## HIGH-EFFICIENCY LED MODULE

*Tiltable from 0° to 30°  
Up to 175 lm/W*

5

## ANTI-VANDALISM

*Anti-theft screws (optional)*

## MOTION DETECTOR

(optional)

- ☑ Lighting or increase in intensity upon detecting movement around the street light
- ☑ Preserves battery life
- ☑ Optimal energy consumption
- ☑ No light pollution
- ☑ Enhanced security

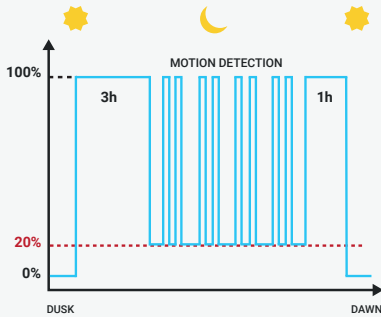
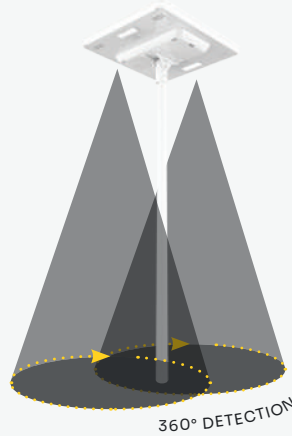

To ensure minimum visibility for all, whatever the time of day, while maximizing energy savings, Sunna Design offers an intelligent detection system.

Based on infrared motion sensors, it easily detects pedestrians, cyclists and slow-moving cars.

A solution that can achieve energy savings of up to 80% in low-traffic areas!

## DATA SUPERVISION

### ☑ SUNNAPP LOCAL POINT-TO-POINT MONITORING

(included)



Install your street lights and interact with your products via long-range Bluetooth.



Installation and commissioning support



Tracking and performance history



Registration and management of the park



Management of lighting profiles

## ■ SMART ENERGY MANAGEMENT



Integrated into iSSL products, **SunnaCore** features advanced **autonomy management**, enabling the battery to provide **optimal service 365 nights a year**, even during periods of low solar irradiation.

## ■ CUSTOMIZED LIGHTING PROFILES

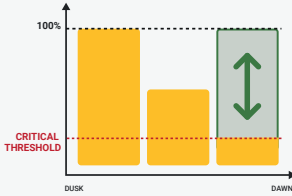

Our lighting profiles are optimized based on daily sunlight.

Based on previous days' weather data and the energy available in the battery, our system automatically regulates light intensity to prevent outages and optimize lighting availability.

## ■ COLOR TEMPERATURES

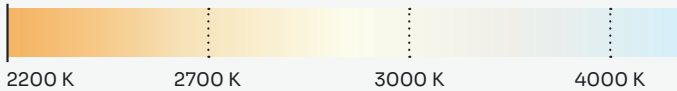

## ■ LIGHT DISTRIBUTION

### NARROW ROAD

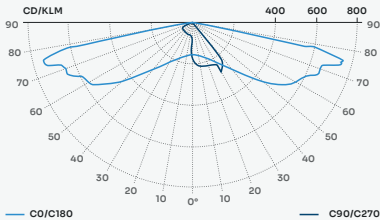

### MEDIUM ROAD

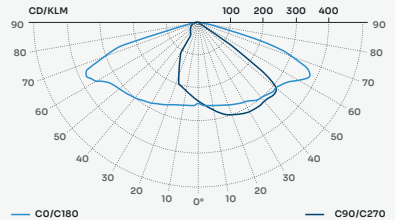

### AREA & WIDE ROAD

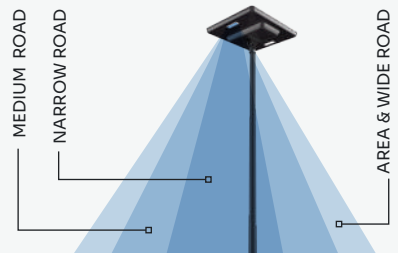
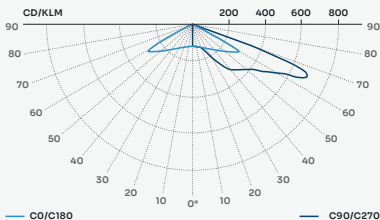

IP65	IK07(PV)	IK08	CE
------	----------	------	----

## LIGHTING

LED Module	High-efficiency LEDs - Multichip technology (IP 67)
Luminous Flux	3,500 to 7,000* lumens
Power consumption	20 W to 40* W
Luminous efficiency	Up to 175 lm/W (4000 K)
Color temperature	2700 K, 3000 K, 4000 K
Lifetime	50,000 hours certified by IESNA LM-80 TM-21
Certificates	EN 60598-1; EN 62471

## SOLAR PANELS

Technology	Photovoltaic module (Monocrystalline silicon)
Power	80 Wc (2 x 40 Wc)
Specifications electrical per panel	Isc = 2,19 A / Voc = 24,17 V / Imp = 2,01 A / Vmp = 19,9 V
Panel dimensions	776 x 350 mm (30.55 x 13.77 in) (x2 solar panels)
Lifetime	> 20 years at 80% of initial power
Tilt	Horizontal (0°)
Structure	Frameless
Certificates	IEC 61215; IEC 61730 I and II

## BATTERIE

Battery technology	NiMH Battery (high resistance to extreme temperatures, maintenance-free)
Voltage	24V
Capacity	240 Wh
Operating temperature	-40°C to +70°C (-40°F to 158°F)
Lifetime	12 years
Certificates	EN 62133

## ELECTRONICS

Technology	SunnaCore®
Communication	Bluetooth
Input voltage	24V
Open circuit voltage	45V
Max charge and discharge current	4.2A
Electrical protection	Electronic fuse
Water resistance	IP65 with waterproof connectors
Certificates	CE; EN61000
Materials	Body ABS PMMA (70% recycled) and aluminum
SCx	0,147 m²

## GENERAL

Mounting	Top mount Ø60 mm
Weight (excluding pole)	19 kg
Options	Motion detector (detection radius: 3 to 5m depending on installation height) / Anti-theft screws / Local or remote supervision

\* Available with motion detection

## PRODUCT CODIFICATION

CODE	COLOR T*	MOTION DETECTOR	LIGHTING PROFILE	COLOR (RAL)	OPTICS	OPTION
SD420 Maxi Area	2	2700K	0 No	0A 100% (3h) / 40% / 100% (1h)	0 White (RAL 9010)	0 Area & Wide Road
	3	3000K	1 Yes	0B 60% (dusk - dawn)	1 Grey brown (RAL 8019)	1 Medium Road
	4	4000K		0C 100% (3h) / 20% + detection 100% / 100% (1h)	2 Black (RAL 9005)	2 Narrow Road
				0E 100% (2h) / 30% / 100% (1h)		
				0G 100% (2h) / 20% + detection 100% / 100% (1h)		
				0L 20% + detection 100%		
				0M 100% (5h) / 40% / 100% (1h)		
				0N 100% (6h) / 0%		
				0Q 50% (3h) / 15% / 50% (1h)		
				0R [50% (3h) / 12% / 50% (1h)] + detection 100%		
				0T 50% (4h) / 0% / 50% (1h)		
				AC 20% + detection 100% (dusk - 23h) / 0% / 20% + detection 100% (5h - dawn)		
				AH 0% + detection 100%		
				AM 100% (dusk - 8:30PM) / 0% / 50% (5AM - dawn - 30min) / 100% (dawn - 30min - dawn)		
				AT 100% (4h) / 0%		
				AU 100% (dusk - 00:00) / 0% / 100% (5AM - dawn)		
				BB 100% (dusk - 11:30PM) / 0% / 100% (5:30AM - dawn)		
				BD 100% (dusk - 10PM) / 0% / 100% (6:30AM - dawn)		
				BG 100% (dusk - dusk + 2h) / 50% (dusk + 2h - 11:30PM) / 0% (11:30PM - 5:30AM) / 50% (5:30AM - dawn - 1h) / 100% (dusk - 1h - dawn)		
				BJ 50% (2h30) + detection 100% / 0% / 50% (2h30) + detection 100%		
BK 100% (2h) / 30% (3h) / 0% / 30% (1h) / 100% (1h)						
BS 100% (3h) / 0% / 100% (2h)						

## DIMENSIONS

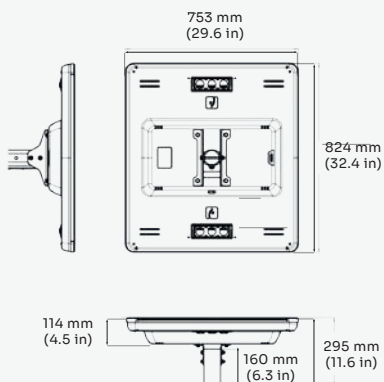

## COLORS



PARC & RECREATION



APPLICATIONS

PARKING LOT



PUBLIC AREA





2024-02



17 rue du Commandant Charcot  
33290 Blanquefort - FRANCE



[contact@sunna-design.com](mailto:contact@sunna-design.com)



[sunna-design.com](https://sunna-design.com)



SOLAR INTELLIGENCE